

CONSTRUCCIÓN MUDULAR

MEDIDAS ESTÁNDAR
3.00 mts x 6.00 mts
h= 2.55 mts

MODULOS

- CONDENEDIR PARA OFICINA
- CONTENEDOR PARA BAÑO
- CONTENEDOR SIMPLE
- CONTENEDOR HABITACIONAL
- DISEÑOS ESPECIALES

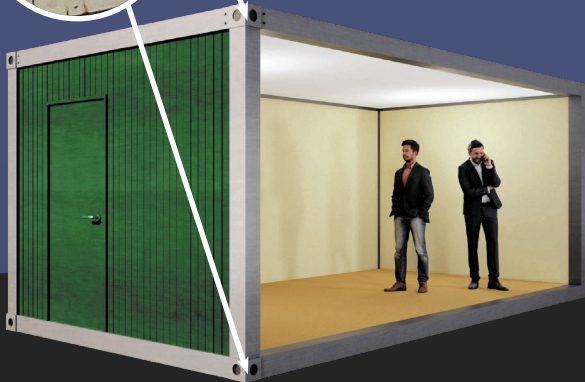

+56 9 5317 6807
eperea@cubiertassur.cl



PALETA DE COLORES



PERFILERIA A PEDIDO

TIPOS DE PERFILES

- CANAL U
- ANGULO INTERIOR
- ANGULO EXTERIOR
- PERFIL L
- CUMBRERA
- CORONACIÓN
- PERFILERIA ESPACIAL

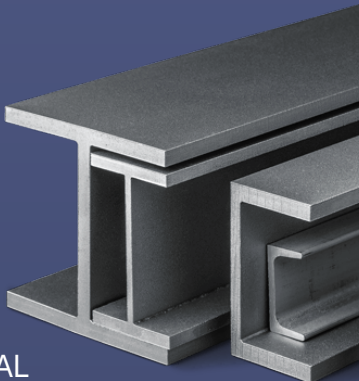

Ventas de Cubiertas
Revestimientos
Hojalateria

3000 MM
LONGITUD

FIJACIONES, SELLO POLIURETANO, SILICONA Y REMACHES

FIJACIONES PARA CORRECTA INSTALACIÓN DE NUESTROS PRODUCTOS

OMEGA

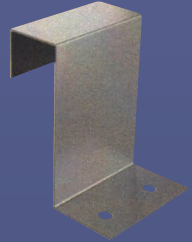
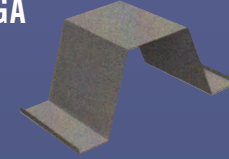

GLIP

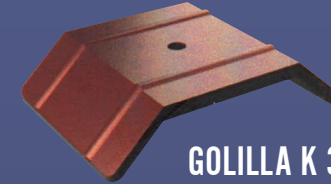

GOLILLA K 35



TAPA CÓNICA



IP 40 CURVO
ANCHO ÚTIL: 970 MM ALTO NERVIOS: 40MM
ANCHO NOMINAL: 1080 MM ESPESOR: 0,5MM

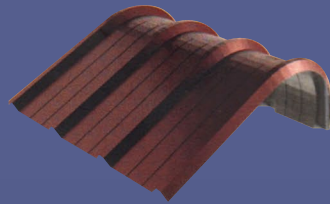

IP 40
ANCHO ÚTIL: 970 MM ALTO NERVIOS: 40MM
ANCHO NOMINAL: 1080 MM ESPESOR: 0,5MM



IP 50
ANCHO ÚTIL: 970 MM ALTO NERVIOS: 35MM
ANCHO NOMINAL: 1080 MM ESPESOR: 0,5MM

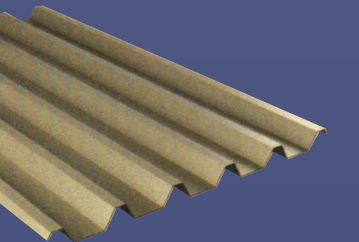

IP 60
ANCHO ÚTIL: 910 MM ALTO NERVIOS: 50MM
ANCHO NOMINAL: 940 MM ESPESOR: 0,5MM



IP 80
ANCHO ÚTIL: 1000 MM ALTO NERVIOS: 25MM
ANCHO NOMINAL: 1050 MM

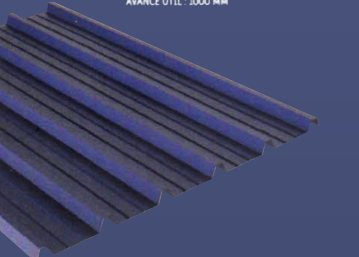

IP 900
ANCHO ÚTIL: 900 MM ALTO NERVIOS: 35MM
ANCHO NOMINAL: 1000 MM



IP TEJA EUROPEA
ANCHO ÚTIL: 1075 MM ALTO NERVIOS: 25MM
ANCHO NOMINAL: 1150 MM

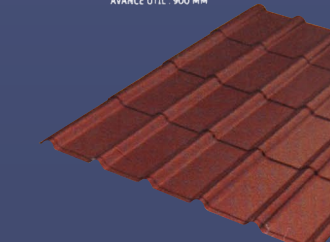

IP ONDULADO 34
ANCHO ÚTIL: 750 MM ALTO NERVIOS: 34MM
ANCHO NOMINAL: 800

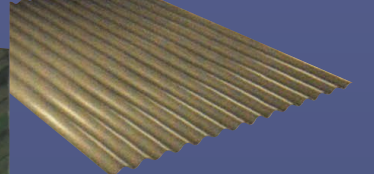

IP TINGLADO
ANCHO ÚTIL: 320 MM ALTO NERVIOS: 15MM
ANCHO NOMINAL: 345 MM

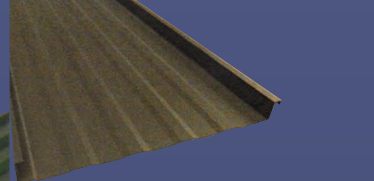

IP CUADRO
ANCHO ÚTIL: 320 MM ALTO NERVIOS: 25MM
ANCHO NOMINAL: 390 MM

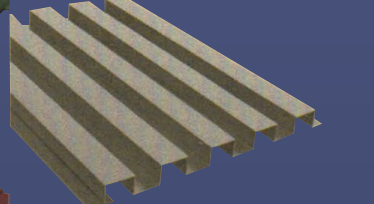

IP 550
ANCHO ÚTIL: 910 MM ALTO NERVIOS: 50MM
ANCHO NOMINAL: 940 MM



IP COLONIAL
ANCHO ÚTIL: 850 MM ALTO NERVIOS: 10MM
ANCHO NOMINAL: 900 MM



IP ONDULADO 18
ANCHO ÚTIL: 1000 MM ALTO NERVIOS: 18MM
ANCHO NOMINAL: 1100 MM

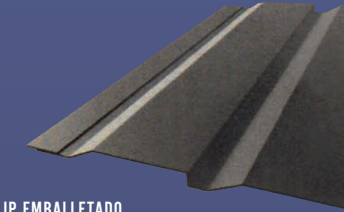

IP EMBALLETADO
ANCHO ÚTIL: 310 - 510 MM ALTO NERVIOS: 35MM
ANCHO NOMINAL: 320 - 520 MM



IP MINI CUADRO
ANCHO ÚTIL: 230 MM ALTO NERVIOS: 15MM
ANCHO NOMINAL: 265 MM

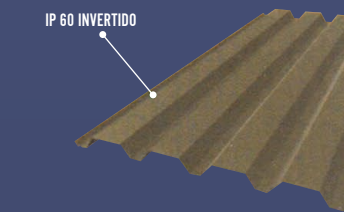

IP 60 INVERTIDO

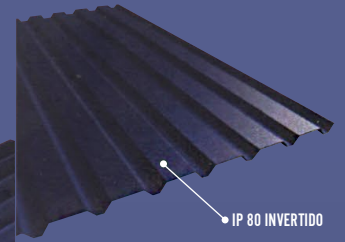

IP 50 AISLADO POL
ANCHO ÚTIL: 970 MM ALTO NERVIOS: 35MM
ANCHO NOMINAL: 1080 MM POL D: 18 - 20KG/M 3 +/-2
PANEL: 50-75-100-150-200 MM



IP ISOPOL WALL
ANCHO ÚTIL: 1180 MM POL D: 18 - 20KG/M 3 +/-2
ANCHO NOMINAL: 1200 MM
PANEL: 50-75-100-150-200 MM

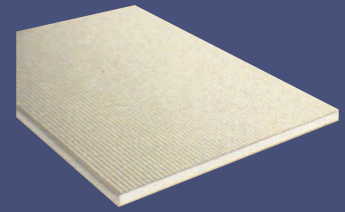

IP ISOPOL LISO
ANCHO ÚTIL: 1180 MM POL D: 18 - 20KG/M 3 +/-2
ANCHO NOMINAL: 1000 MM
PANEL: 50-75-100-150-200 MM



IP 725
ANCHO ÚTIL: 1000 MM ALTO NERVIOS: 25MM
ANCHO NOMINAL: 1050 MM

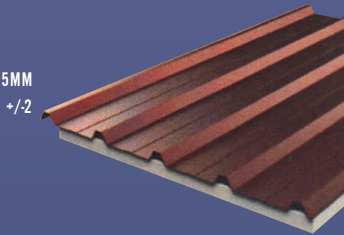

IP 40 AISLADO POL
ANCHO ÚTIL: 970 MM ALTO NERVIOS: 40MM
ANCHO NOMINAL: 1080 MM POL D: 18 - 20KG/M 3 +/-2
PANEL: 50-75-100-150-200 MM

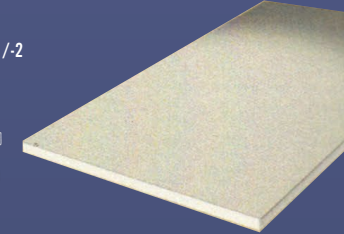

IP ISOPOL FRISO
ANCHO ÚTIL: 1180 MM POL D: 18 - 20KG/M 3 +/-2
ANCHO NOMINAL: 1200 MM
PANEL: 50-75-100-150-200 MM

